

# Design of an Experimental Apparatus to Test the Alkali-Metal Heat Pipes for Space Fission Power

Sung Deok Hong\* and Chan Soo Kim

Korea Atomic Energy Research Institute, 111, Daedeok-daero 989 Beon-gil, Yuseong-gu, Daejeon 34057, Korea

\*Corresponding author: sdhong1@kaeri.re.kr

## 1. Introduction

For future space transportation and surface power applications, a small nuclear fission power system (Kilopower system) is leading the R&D efforts [1, 2]. Thermal energy of the reactor core is transferred to the Stirling converters through a series of sodium heat pipes. The waste heat from the Stirling converters is transferred to the radiator panels through water heat pipes and is rejected into the space (Figure 1). This system would have more than 10 year design life and have a plan to generate 1 to 10 kW of electricity through Stirling system.

The alkali-metal heat pipes has great credit on small nuclear fission reactors, but still there are lack of experimental validation such as the heat transfer performances at a very high-temperature operating condition, at a not strait or curved geometry and at various wick structures including hybrid-wick structure [3]. We designed an experimental apparatus to test the alkali-metal heat pipes that installed various-kind of wick structures shall be apply to the space fission reactor.

## 2. Heat Pipes

Alkali-metal heat pipe is a good candidate of the heat transfer device in the space fission reactor because the heat pipe can rapidly transfer the high-temperature heat of 800°C from the fission reactor core to a Stirling system. A wick structure is the major design parameter determining the heat transfer performance of heat pipe. There are three types of wicks for heat pipe that carry significant power over a Stirling system : arterial wick, grooved wick and self-venting arterial wick [2,3,4]. Arterial heat pipes have traditionally, been the default design for spacecraft nuclear reactors due to their ability to carry significant power. However, degassing of the artery due to non-condensable gas (NCG) generation is a serious potential problem. There is no method to remove the vapor or NCG from the artery once the heat pipe is operating; therefore re-priming the heat pipe becomes impossible. Grooved and self-venting heat pipes offer potential benefits over the standard arterial heat pipes in regards to the de-priming issue. The grooves cannot be de-primed due to the liquid flow path being open to the vapor space. The self-venting pipes are less susceptible to de-priming due to venting pores located in the evaporator that allow trapped NCG or vapor to escape into the vapor space.

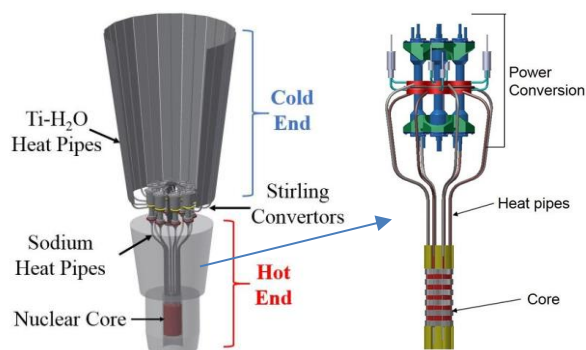

Fig. 1. Conceptual design layout of a Kilopower system [1, 2].

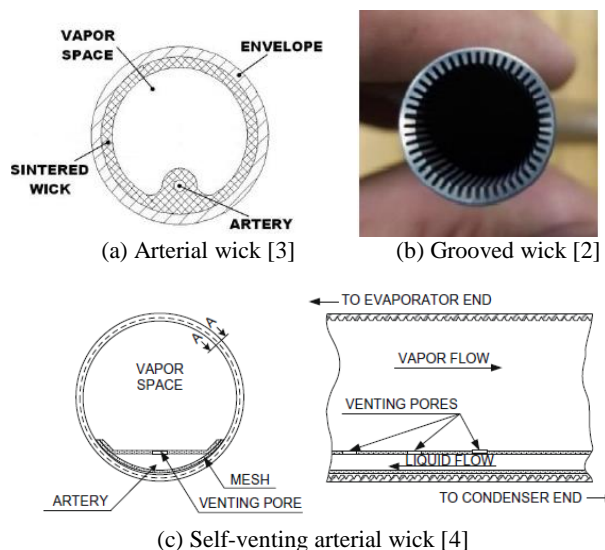

Fig. 2. Heat pipe wicks suitable for use in a space fission reactor.

## 3. Experimental Apparatus

### 3.1. Design of Experimental Apparatus

The experimental apparatus is composed of furnace type evaporator, a condenser, a water cooling system and adiabatic zone formed by Kaowool insulator as shown in Figure 3. The operating condition of the test apparatus is as follows;

- o Fluid
  - Heat pipe Sodium
  - Condenser Water or Helium
- o Evaporator
  - Power ~ 6.0 kW
  - Temperature ~ 1425 °C

- o Condenser
  - Pressure ~ 10.0 bar
  - Temperature (water) < 200 °C
  - Flowrate (water) ~ 0.05 kg/s

The physical parameters that will be measured are the electric power, temperature, heat loss, and coolant flowrate.

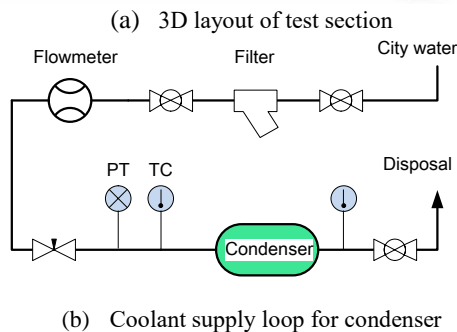
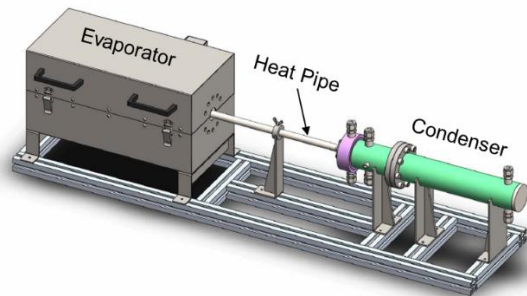

Fig. 3. Layout of experimental apparatus.

### 3.2. Evaporator

Evaporator is a furnace type heater simulating reactor core thermal condition (Max. temperature to 1425°C). A Kanthal heater molded with Ceramic Kaowool material can generate up to 6 kW thermal power. The heater is surrounded by thick Kaowool-insulator to minimize heat loss to the environment as shown in Figure 4. Two variable AC autotransformers, Slidacs, will be connected to the evaporator for control the power manually.

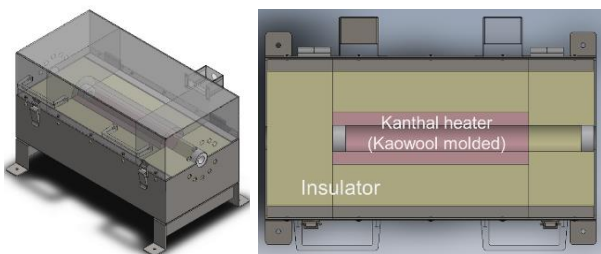

Fig. 4. Evaporator.

### 3.3. Condenser

A water-pool type condenser is designed. It is convenient to measure the maximum heat transfer rate of various heat pipes because water has higher heat removal

capacity than gas. The condenser has heat pipe guides, thermocouple port, an assembling flange and a sealing adaptor (Figure 5). This condenser has total of 6kW heat rejection capacity when the temperature difference between coolant inlet and outlet is 50°C with flowrate of 0.03 kg/s (Table I).

A problem is aroused in designing high-temperature sealing of this condenser because the surface temperature of alkali-metal heat pipe shall increase up to 750°C at normal operating condition. As an interim design stage, we invented a graphite-sealing adapter that will withstand up to 450°C as shown in Figure 5. Later, we will replace the adapter as a Lava-sealing adapter that shall be withstand up to 870°C.

Table I: Condenser thermal hydraulic data

Parameter	Unit	Value
Cooling capacity	kW	6.0
Pressure	bar	1.0
Condenser in/out temp.	°C	20/70
Flow rate	kg/s	0.029
Diameter (nozzle)	mm	10.9
Coolant velocity (nozzle)	m/s	0.31

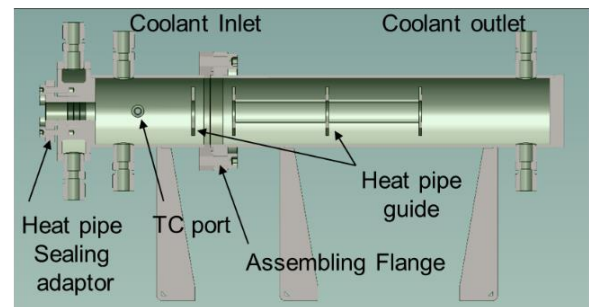

Fig. 5. Condenser.

### 3.4. Test Section

Sodium Heat Pipe (HP) has 3/4" diameter and 1.0 meter long tube geometry. The HP is filled with 50 grams of sodium that is the amount of emerging all the screen wicks installed in the HP internal. Figure 6 shows the layout of test section installed in both evaporator and condenser. 25cm of HP is inserted into the evaporator and 20cm inserted condenser, and the other 55cm is opened at adiabatic region. K-type thermocouples are attached on the HP wall surface as shown the Figure 6. Stainless Steel bands fix the thermocouples except the evaporator region. In the evaporator region, the thermocouples are attached to the HP wall surface manually through the holes prepared to thermocouples at the ceramic blocks (insulator) in the evaporator.

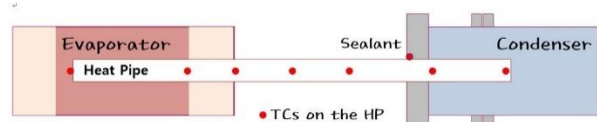

Fig. 6. Test section layout and thermocouple points

#### 4. Commissioning Results

Some interesting facts are acquainted on the commissioning test. First, the sodium melts slowly if not insulated at the adiabatic region. When we wrap a Kaowool insulator on the adiabatic region, the melting was done fast. One hour later after turn on the evaporator power, the surface temperatures at adiabatic region increased subsequently by more than 400°C after the temperature rises in the order close to the temperature at the evaporator as shown in Figure 7. At the sealant location, we have to wait a long time until the sodium melt. The reason is that the condenser filled with cold water. When the temperature at the sealant location reaches 330°C, a temperature fluctuation is started. As represented a small icon in the Figure 7, the amplitude of temperature is from  $\pm 10$  to  $\pm 15^\circ\text{C}$ . The fluctuating temperature initially decreases briefly and then increase again. This fluctuation tends to decrease as the temperature rises. The temperature at the condenser region follows very slowly to the temperature of sealant location. When a certain temperature is reached, the temperature at the condenser region 1 fluctuates with an amplitude that is several times larger than that of the sealant location. When water is supplied, the temperature dropped rapidly.

Meanwhile, the maximum temperature of the evaporator is maintained so as not to exceed 1200°C. Compared to the rate of temperature increase of the maximum evaporator temperature, the temperature of the HP wall in evaporator continued to increase to 900°C.

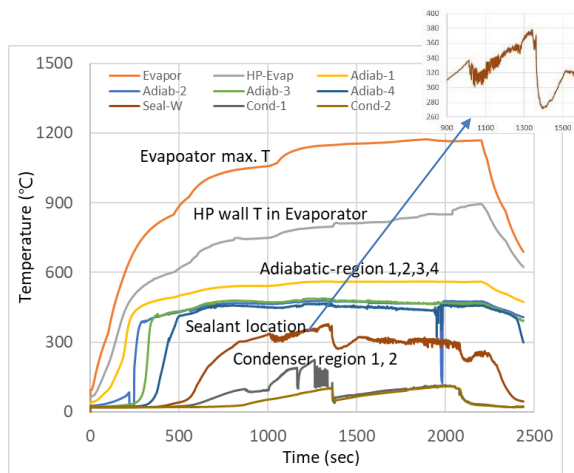

Fig. 7. Commissioning results (evaporator Max. temperature 1 case, heat pipe wall temperature 8 cases)

#### 5. Conclusion

We designed an experimental apparatus to test the alkali-metal heat pipes that installed various-kind of wick structures shall be apply to the space fission reactor. Proper design and operation of condenser is an important work to figure out accurate measurement of heat transfer

performance of a heat pipe in which have various kind of wicks as acquired in a commission test result. High temperature sealing adapter allows direct immersion of heat pipe to coolant that makes accurate measurement of heat transfer rate. Our condenser has advanced function than jacket type condenser, but it has a handicap that need to additional high temperature sealing adaptor.

#### ACKNOWLEDGEMENTS

This study was supported by the National Research Foundation of Korea (NRF) grant funded by the Korea government (2019M2D1A1058139).

#### REFERENCES

- [1] M. A. Gibson, S. R. Oleson, D. I. Poston and P. McClure, "NASA's Kilopower Reactor Development and the Path to Higher Power Missions," in IEEE Aerospace Conference, Big Sky, MT, 2017.
- [2] K. L. Walker, C. Tarau, and W. G. Anderson "Alkali Metal Heat Pipes for Space Fission Power," Nuclear and Emerging Technologies for Space (NETS-2013), Albuquerque, NM, February 25-28, 2013
- [3] L. Mason and C. Carmichael, "A Small Fission Power System with Stirling Power Conversion for NASA Science Missions," Nuclear and Emerging Technologies for Space (NETS-2011), Albuquerque, NM, February 7-10, 2011.
- [5] T. Kaya, Analysis of vapor-gas bubbles in a single artery heat pipe, Int. J. Heat Mass Transfer 52 (2009) 5731–5739.
- [4] K. L. Lee, C. Tarau and W. G. Anderson, Titanium Water Heat Pipe Radiators for Space Fission System Thermal Management, Joint 19th IHPC and 13th IHPS, Pisa, Italy, June 10-14, 2018