

Condensation Characteristics in Bundle Tubes of the PCCS (Passive Containment Cooling System) Heat Exchanger

Byoung-Uhn Bae*, Seok Kim, Yu-Sun Park, Kyoung-Ho Kang

Korea Atomic Energy Research Institute, 989 - 111, Daedeok-daero, Yuseong-gu, Daejeon

* Corresponding author : bubae@kaeri.re.kr

1. Introduction

Conceptual design of i-POWER (Innovative Passive Optimized Worldwide Economical Reactor) implements a passive containment cooling system (PCCS) to cool down a reactor containment by replacing an active containment spray system [1]. A cooling mechanism of the PCCS heat exchanger is condensation of a steam-gas mixture on surface of the tubes, which is submerged in a water pool, PCCT (Passive Condensation Cooling Tank). In this study, the condensation heat transfer characteristics of the heat exchanger was experimentally investigated using CLASSIC (Condensation Loop for Advanced Safety System In Containment) test facility. The test matrix included both single bare tube and the bundle tubes. From results of condensation heat transfer in the single tube tests, an experimental correlation for the condensation heat transfer coefficient was suggested. It was utilized to quantitatively compare the condensation heat transfer characteristics in the bundle heat exchanger tube, so that a distribution of the local condensation heat transfer coefficient of tubes was quantitatively compared.

2. Test Facility

CLASSIC test facility was constructed for verifying the flow stability and heat removal capability of PCCS [2]. It is composed of a CSV (containment simulating vessel), a PCCT, a vertical heat exchanger tube, a circulation pump, flow control valves, pipings, and their supporting structures. The fluid system of the test facility was designed to satisfy the geometric, kinematic, and thermodynamic similarities so that various thermal hydraulic phenomena around the PCCS heat exchanger tube can be reproduced.

Figure 1 shows a schematic of the coolant circulation system. The coolant coming from the PCCT is distributed to the heat exchanger tube, and the heated coolant is returned to the PCCT. The amount of heat removal by the heat exchanger tube can be measured by a difference of the fluid enthalpy between tube inlet and outlet. The condensation heat transfer coefficient can be estimated with considering the heat flux, the bulk temperature in the CSV, and the tube outer wall temperature.

The tests for the condensation heat transfer were performed in the geometries of both a single tube heat exchanger and a bundle tube heat exchanger. In the case of the single tube test, a single bare heat exchanger tube with the equivalent diameter, thickness, and length as the prototype PCCS heat exchanger design of i-POWER was installed in the CSV. After completing the single tube tests, the heat exchanger in the CSV was replaced by the bundle tube. A total of 18 heat exchanger tubes with equivalent arrangement to the prototype PCCS design were installed in the CSV as shown in Fig. 2. Among them, three tubes (#11, 14, 17) incorporated four points of the outer wall temperature measurement to investigate the condensation characteristics around the tube.

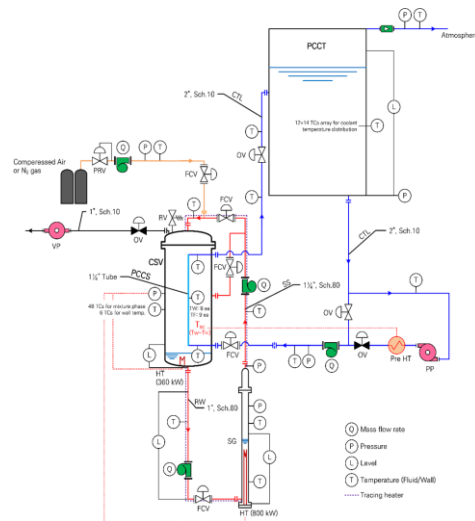

Fig. 1. Schematic diagram of the CLASSIC test facility [2]

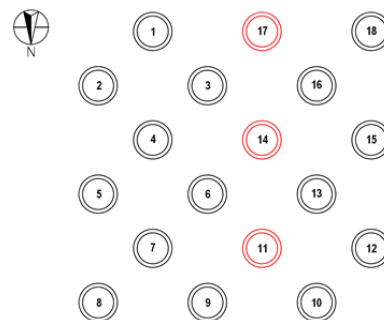

Fig. 2. Layout of the bundle bare heat exchanger tube

3. Result and Discussion

3.1 Single tube experiment

To investigate the condensation heat transfer characteristics of PCCS heat exchanger and provide a reference correlation for comparing the condensation heat transfer coefficient to the bundle tubes, the tests with a single tube heat exchanger were performed in the CLASSIC facility. For developing the condensation model from the single tube test result, a Nusselt number ($Nu_D = hD/k$) was considered to correlate the condensation heat transfer coefficient (h). The characteristic length in the Nu is an outer diameter of the tube (D), and the thermal conductivity of the steam-gas mixture at a bulk condition (k) was estimated. Among various models for the condensation heat transfer coefficient of a steam-gas mixture, this study referred a non-dimensional formulation of Dehbi (2015) [3]. It derived the condensation model by a heat and mass transfer analogy (HMTA), including a curvature effect for a round tube surface and a suction effect toward the gas boundary layer. For a regression analysis using the CLASSIC test data with the single tube, the suction effect was considered by additionally including an effect of the Prandtl number (Pr) for the mixture. The result of the regression analysis from all data of the single tube test was given in Eq. (1), so that a Nusselt number for the condensation heat transfer coefficient of the PCCS heat exchanger tube could be formulated as Eq. (2). The proposed correlation showed a reasonable prediction capability for the condensation heat transfer coefficients, which was within $\pm 20\%$ difference compared to the test results as presented in Fig. 3.

$$\phi_{PCCS} = 0.689Pr^{-1.25}\phi_{Dehbi} = 0.916Pr^{-1.25} \cdot \frac{\ln(1+B)}{B} \quad (1)$$

$$Nu_{PCCS} = \phi_{PCCS} \cdot \left(\frac{Nu_{cyl}}{Nu_{flat}} \right)_{Cebeci} \cdot Nu_{HMTA} \quad (2)$$

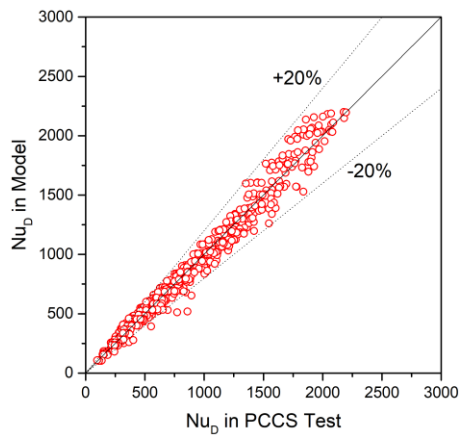

Fig. 3. Comparison of the Nusselt number for the single tube tests in the CLASSIC facility

3.2 Bundle tube experiment

The condensation heat transfer characteristics in the bundle tubes was investigated in the CLASSIC test facility with installing 18 tubes as shown in Fig. 2. Test condition and procedure were similar to those of the single tube test, where the total pressure of the mixture, the mass fraction of the non-condensable gas, and the wall subcooling were varied for each test.

The average condensation heat transfer coefficient in the bundle tube test was compared to the condensation model in Eq. (2). From the comparison result as shown in Fig. 4, the condensation heat transfer model was in a good agreement with the average heat transfer coefficient of the bundle tube geometry, even though the model was developed from the single tube tests. The average heat transfer coefficients in the bundle tube geometry can be quantitatively compared by introducing a ratio of the average heat transfer coefficient to the model, as defined in Eq. (3). The average of the ratio in all test cases was estimated as 0.981. It pointed out the condensation model has sufficiently reflected the effect of crucial properties such as the mass fraction of non-condensable gas or the average of the wall subcooling.

$$R = \frac{\text{Average HTC in bundle tube}}{\text{HTC model by single tube test}} \quad (3)$$

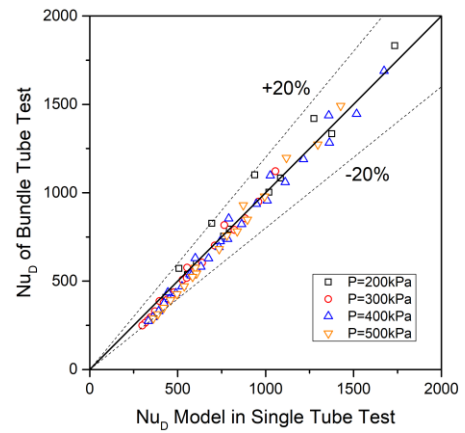

Fig. 4. Comparison of the condensation model for bundle tube tests

Using the condensation heat transfer coefficient from the single tube tests in design of the PCCS heat exchanger can make an over-estimation of the condensation heat removal due to a reduction of the condensation heat transfer by the shadow effect of the non-condensable gas [4]. It is due to an enhanced accumulation of the non-condensable gas around the inside tubes from the condensation on neighboring tubes, so that a larger boundary layer of the non-condensable gas on the surface of inside tube inhibits condensation of the steam-gas mixture.

Table I. R values for averaging groups of the bundle tube

Averaging group	All tubes	Single row	Inside tubes	Outside tubes
Arrangement of the tubes				
Average of R values	0.981	0.939	0.931	1.041

Table I compares the average R values for several groups in the bundle tube tests. The ratio was less than 1.0 for the inside tubes of the bundle geometry in the CLASSIC facility, while that was larger than 1.0 for the outside tubes. Considering 42 X 8 arrangement of the prototype PCCS heat exchanger tubes, the ratio of the heat transfer coefficient for a single row in the CLASSIC test facility was estimated around 0.94. It means that a degradation of the average condensation heat transfer by about 6 % can be expected in the present design of the bundle heat exchanger tubes for the PCCS of iPOWER.

4. Conclusions

The condensation heat transfer characteristics of the PCCS heat exchanger tubes were experimentally investigated in the CLASSIC test facility. From the results in the single tube test, a non-dimensional correlation was derived with considering the conventional HMTA and the parameters affecting the condensation of the steam-gas mixture. In the bundle tube test, the comparison of the Nusselt number for each tube showed a local degradation of the condensation heat transfer in the tubes located inside the bundle geometry, since the concentration of the non-condensable gas was increased around the inside tubes. The decrease of the average heat transfer coefficient for the inside tubes was estimated as about 6 %, which points out that a design of the PCCS should take into account the degradation of the condensation due to the shadow effect.

The present test results will contribute to providing benchmark data for validating the calculation performance of a thermal hydraulic system analysis code with respect to the PCCS.

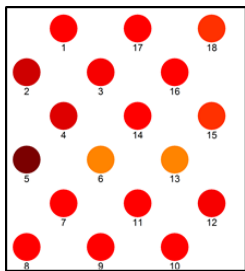
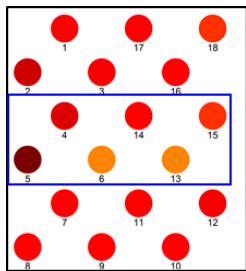
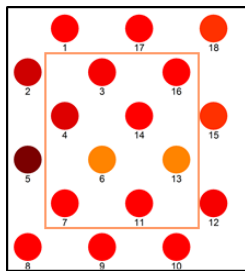
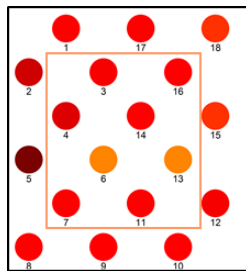
ACKNOWLEDGMENTS

This work was supported by a Nuclear Research & Development program of the Korea Institute of Energy Technology Evaluation and Planning (KETEP) grant funded by the Ministry of Trade, Industry, & Energy of the Korean government. (number 20161510400120)

REFERENCES

- [1] S.W. Lee et al., "The Concept of the Innovative Power Reactor", Nuclear Engineering and Technology, vol. 49, pp. 1431-1441, 2017.
- [2] Y. S. Park et al., "Construction Report of Separate Effect Test Facility for PCCS", S15LM02-3-007, Korea Atomic Energy Research Institute, 2016.
- [3] A. Dehbi, "A generalized correlation for steam condensation rates in the presence of air under turbulent free convection", International Journal of Heat and Mass Transfer, vol. 86, pp. 1-15, 2015.
- [4] J. H. Kang et al., "An Experimental Investigation of Steam-Air Mixture Condensation with Bundle Heat Exchanger Under Free Convection", NTHAS10: The Tenth Korea-Japan Symposium on Nuclear Thermal Hydraulics and Safety, Kyoto, Japan, November 27-30, 2016.